

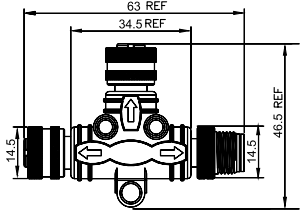









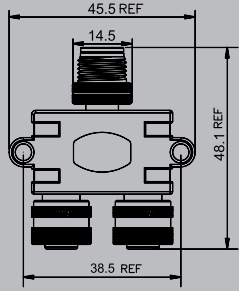

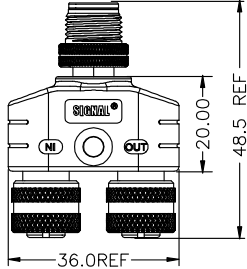

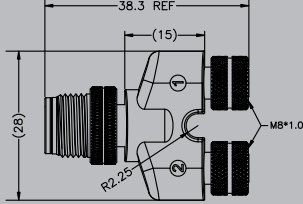
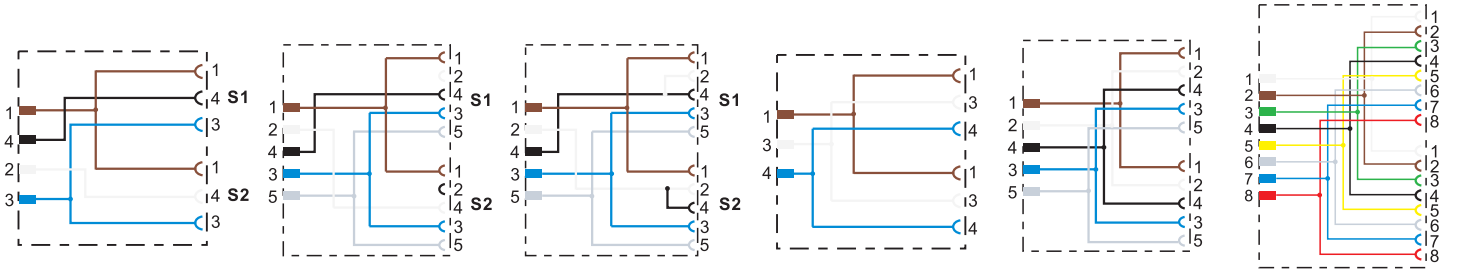

M12 转接头连接器 / M12 Adapter Connector

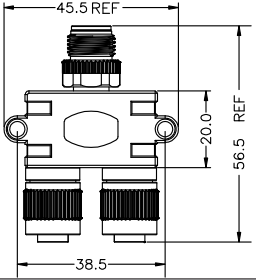
产品图 Product picture	订货号 Order No.	芯数 Poles	编码 Coding	额定电流 Current rating	额定电压 Voltage rating	尺寸图 Scale diagram
	120104-10-005	4	A	4A	250V	
	120105-10-005	5	A	4A	60V	
	120108-10-007	8	A	2A	30V	
	120104-10-007	4	A	4A	250V	
	120105-10-008	5	A	4A	60V	
	120108-10-010	8	A	2A	30V	
	120104-10-045	4	A	4A	250V	
	120105-10-074	5	A	4A	60V	
	120108-10-047	8	A	2A	30V	
	120103-10-001	3	A	4A	60V	
	120104-10-042	4-3	A	3A	60V	

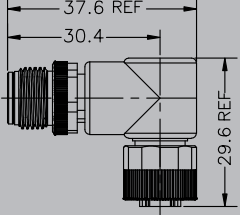
	120104-10-005	120104-10-005		120105-10-005	120108-10-007
120104-10-042	120104-10-007	120104-10-007	120103-10-001	120105-10-008	120108-10-010
	120104-10-045	120104-10-045		120105-10-074	120108-10-047

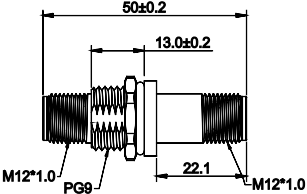

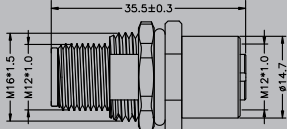

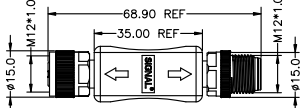



M12 转接头连接器 / M12 Adapter Connector

产品图 Product picture	订货号 Order No.	芯数 Poles	编码 Coding	额定电流 Current rating	额定电压 Voltage rating	尺寸图 Scale diagram
	120808-10-001	8	Y	6A+0.5A	60V	
	120708-10-012	8	X	0.5A	60V	
	120104-10-002	4	A	4A	250V	
	120404-10-002	4	D	4A	250V	
	120105-10-002	5	A	4A	60V	
	120205-10-002	5	B	4A	60V	
	120108-10-002	8	A	2A	30V	
	120112-10-002	12	A	1.5A	30V	
	120104-10-001	4	A	4A	250V	
	120404-10-001	4	D	4A	250V	
	120105-10-001	5	A	4A	60V	
	120205-10-001	5	B	4A	60V	
	120108-10-001	8	A	2A	30V	
	120112-10-001	12	A	1.5A	30V	
	120104-10-047	4	A	4A	250V	
	120404-10-032	4	D	4A	250V	
	120105-10-066	5	A	4A	60V	
	120205-10-017	5	B	4A	60V	
	120108-10-050	8	A	2A	30V	
	120112-10-018	12	A	1.5A	30V	

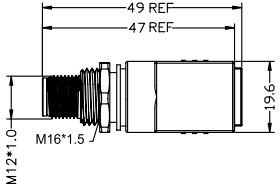
M12 转接头连接器 / M12 Adapter Connector

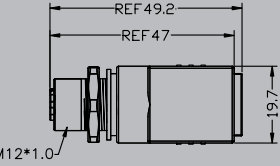
产品图 Product picture	订货号 Order No.	芯数 Poles	编码 Coding	额定电流 Current rating	额定电压 Voltage rating	尺寸图 Scale diagram
	120504-10-001	3+PE	S	12A	630V	
	120604-10-001	4	T	12A	63V	
	121005-10-001	4+FE	L	16A	63V	
	121305-10-001	4+PE	K	12A	630V	
	120504-10-002	4+FE	S	12A	630V	
	120604-10-002	4	T	12A	63V	
	121005-10-002	4+FE	L	16A	63V	
	121305-10-002	4+PE	K	12A	630V	

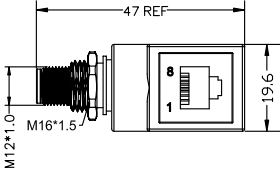

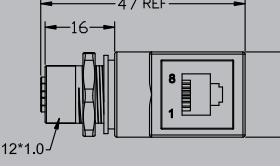
M12 对 RJ45 转接头 / M12 to RJ45 Adapter

产品图 Product picture	订货号 Order No.	芯数 Poles	编码 Coding	额定电流 Current rating	额定电压 Voltage rating	尺寸图 Scale diagram
	120404-10-006	4	D	4A	250V	
	120108-10-014	8	A	2A	30V	
	120708-10-006	8	X	0.5A	50V AC / 60V DC	
	120404-10-004	4	D	4A	250V	
	120108-10-004	8	A	2A	30V	
	120708-10-007	8	X	0.5A	50V AC / 60V DC	
	120404-10-005	4	D	4A	250V	
	120108-10-015	8	A	2A	30V	
	120708-10-004	8	X	0.5A	50V AC / 60V DC	
	120404-10-003	4	D	4A	250V	
	120108-10-003	8	A	2A	30V	
	120708-10-005	8	X	0.5A	50V AC / 60V DC	





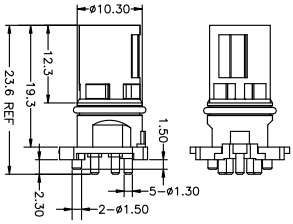





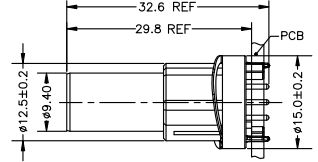

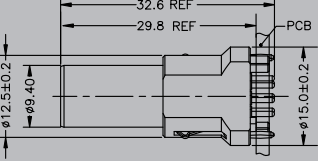
M12 贴片式连接器 / M12 SMT Connector

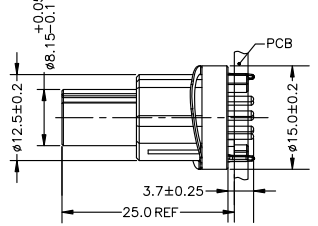
产品图 Product picture	订货号 Order No.	芯数 Poles	编码 Coding	额定电流 Current rating	额定电压 Voltage rating	接线方式 Termination	尺寸图 Scale diagram
	120104-03-027	4	A	4A	250V	SMT	
	120105-03-023	5	A	4A	60V	SMT	
	120108-03-034	8	A	2A	30V	SMT	
	120112-03-022S	12	A	1.5A	30V	SMT	
	120104-04-019	4	A	4A	250V	SMT	
	120404-04-053	4	D	4A	250V	SMT	
	120105-04-023	5	A	4A	60V	SMT	
	120205-04-015	5	B	4A	60V	SMT	
	120108-04-021	8	A	2A	30V	SMT	
	120708-04-005 black insert 黑色胶芯	8	X	0.5A	50V AC 60V DC	SMT	
	120708-04-014 white insert 白色胶芯						
	FWK00817	—	—	—	—	—	
	FWK00818	—	—	—	—	—	

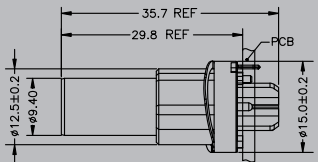
M12 THR 连接器 / M12 THR Connector

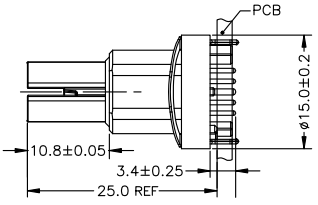
产品图 Product picture	订货号 Order No.	芯数 Poles	编码 Coding	额定电流 Current rating	额定电压 Voltage rating	接线方式 Termination	尺寸图 Scale diagram
	120404-03-043	4	D	4A	250V	THR	
	120105-03-184	5	A	4A	60V		
	120108-03-145	8	A	2A	30V		
	120112-03-087	12	A	1.5A	30V		
	120117-03-043	17	A	1.5A	30V		
	120404-04-151	4	D	4A	250V	THR	
	120105-04-147	5	A	4A	60V		
	120205-04-029	5	B	4A	60V		
	120108-04-054	8	A	2A	30V		
	120112-04-063	12	A	1.5A	30V		
	120117-04-038	17	A	1.5A	30V		
	121005-03-016	5	L	16A	63V	THR	
	121005-04-017	5	L	16A	63V	THR	
	120604-03-002	4	T	12A	63V	THR	
	FWK00815	—	—	—	—	—	
	FWK00816	—	—	—	—	—	

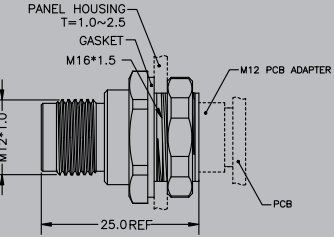
M12 分体式连接器 / M12 PCB adapter

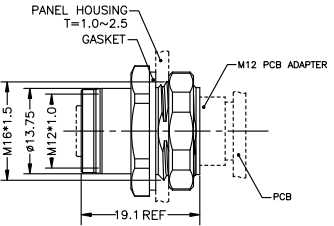
产品图 Product picture	订货号 Order No.	芯数 Poles	编码 Coding	额定电流 Current rating	额定电压 Voltage rating	接线方式 Termination	尺寸图 Scale diagram
	120104-03-153	4	A	4A	250V	PCB	
	120105-03-185	5	A	4A	60V		
	120108-03-151	8	A	2A	30V	PCB	
	120104-04-138	4	A	4A	250V	PCB	
	120404-04-149	4	D	4A	250V		
	120105-04-150	5	A	4A	60V		
	120108-04-146	8	A	2A	30V		
	120504-03-018	4	S	12A	630V	PCB	
	120708-04-089	8	X	0.5A	50V AC 60V DC	PCB	
	FWK00813	—	—	—	—	—	
	FWK00814	—	—	—	—	—	

M12 连接器 / M12 Connector



产品参数 Product Data

工作温度 Operating temperature: -25°C ~ +85°C
 插拔次数 Mechanical operation: > 100次
 防护等级 Protection degree: IP67/IP68
 接触电阻 Contact resistance: ≤5mΩ
 绝缘电阻 Insulation resistance: ≥100MΩ

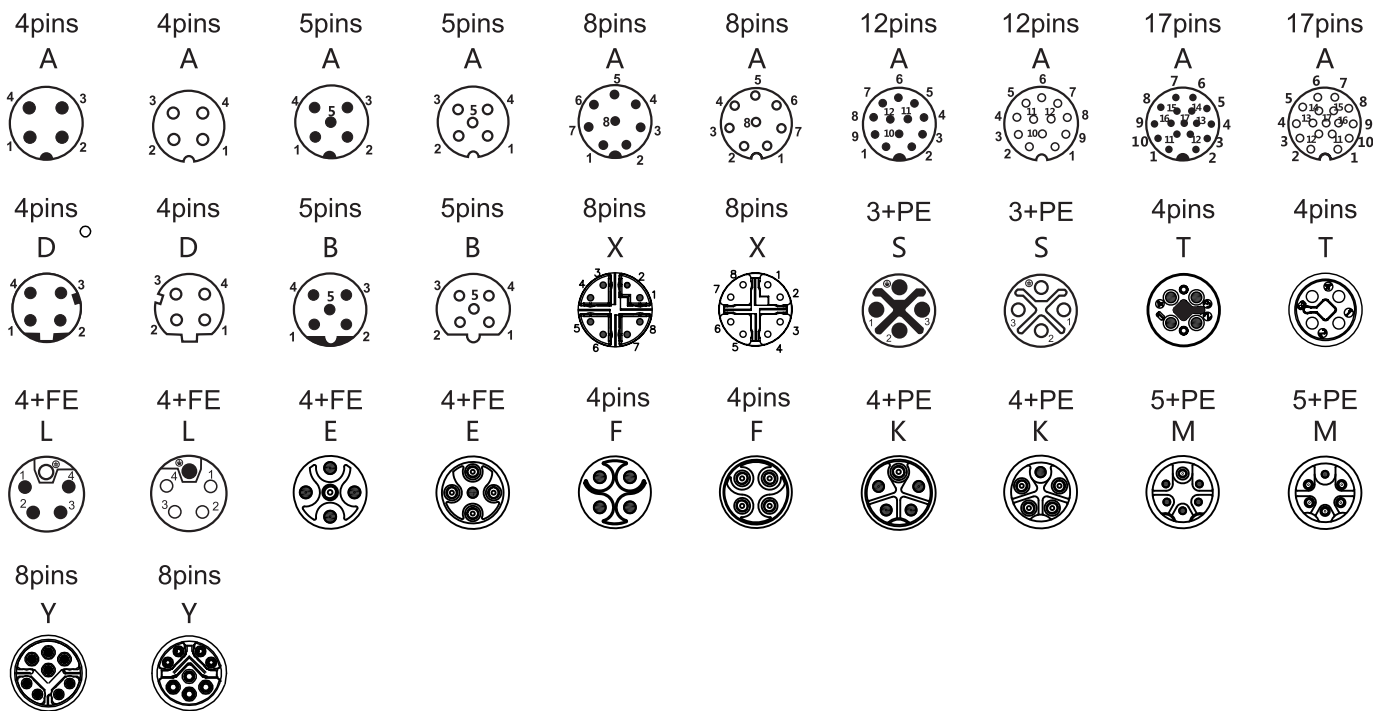
插针材料 Pin contact: CuZn
 插孔材料 Socket contact: CuSn
 针孔镀层材料 Contact plating: Au

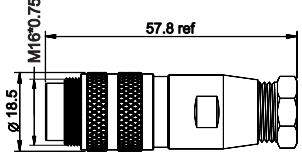

M16 组装式连接器 / M16 Assembly Connector

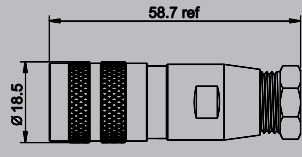
产品图 Product picture	订货号 Order No.	芯数 Poles	额定电流 Current rating	额定电压 Voltage rating	接线方式 Termination	接线外径 Cable OD	尺寸图 Scale diagram
	160002-01-001	2	5A	100V	焊接/solder	5~7.5mm	
	160003-01-002	3	5A	100V	焊接/solder	5~7.5mm	
	160004-01-001	4	5A	100V	焊接/solder	5~7.5mm	
	160005-01-001	5	5A	63V	焊接/solder	5~7.5mm	
	160005-01-002	5(DIN)	5A	32V	焊接/solder	5~7.5mm	
	160006-01-001	6	5A	63V	焊接/solder	5~7.5mm	
	160007-01-001	7	5A	63V	焊接/solder	5~7.5mm	
	160007-01-002	7(DIN)	5A	32V	焊接/solder	5~7.5mm	
	160008-01-001	8	5A	32V	焊接/solder	5~7.5mm	
	160012-01-001	12	1A	32V	焊接/solder	5~7.5mm	
	160014-01-001	14(DIN)	1A	32V	焊接/solder	5~7.5mm	
	160016-01-001	16	1A	32V	焊接/solder	5~7.5mm	
	160019-01-001	19	1A	32V	焊接/solder	5~7.5mm	
	160024-01-002	24	1A	32V	焊接/solder	5~7.5mm	
	160002-02-001	2	5A	100V	焊接/solder	5~7.5mm	
	160003-02-002	3	5A	100V	焊接/solder	5~7.5mm	
	160004-02-002	4	5A	100V	焊接/solder	5~7.5mm	
	160005-02-001	5	5A	63V	焊接/solder	5~7.5mm	
	160005-02-002	5(DIN)	5A	32V	焊接/solder	5~7.5mm	
	160006-02-001	6	5A	63V	焊接/solder	5~7.5mm	
	160007-02-001	7	5A	63V	焊接/solder	5~7.5mm	
	160007-02-002	7(DIN)	5A	32V	焊接/solder	5~7.5mm	
	160008-02-001	8	5A	32V	焊接/solder	5~7.5mm	
	160012-02-001	12	1A	32V	焊接/solder	5~7.5mm	
	160014-02-001	14(DIN)	1A	32V	焊接/solder	5~7.5mm	
	160016-02-001	16	1A	32V	焊接/solder	5~7.5mm	
	160019-02-001	19	1A	32V	焊接/solder	5~7.5mm	
	160024-02-001	24	1A	32V	焊接/solder	5~7.5mm	







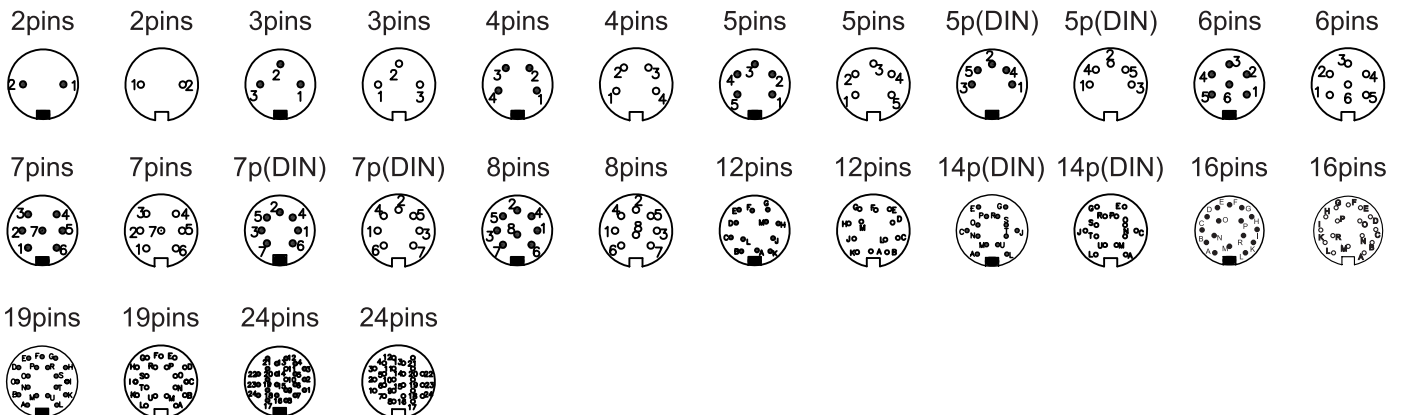



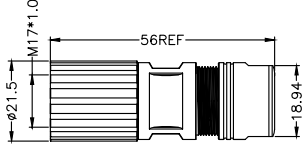

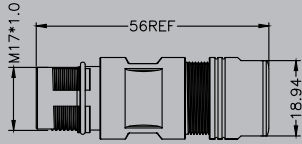
产品参数 Product Data

工作温度 Operating temperature: -25°C ~ +85°C
 插拔次数 Mechanical operation: > 100次
 防护等级 Protection degree: IP67/IP68
 接触电阻 Contact resistance: ≤5mΩ
 绝缘电阻 Insulation resistance: ≥100MΩ







插针材料 Pin contact: CuZn
 插孔材料 Socket contact: CuSn
 针孔镀层材料 Contact plating: Au



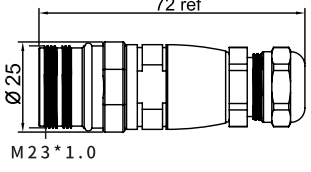

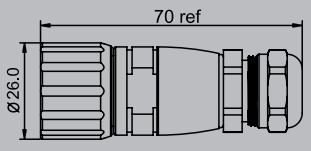

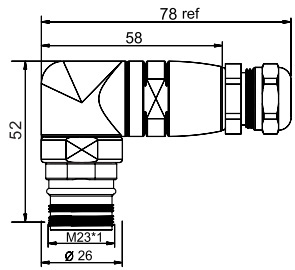

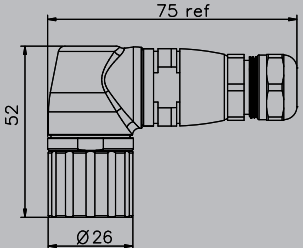
M17 组装式连接器 / M17 Assembly Connector

产品图 Product picture	订货号 Order No.	芯数 Poles	额定电流 Current rating	额定电压 Voltage rating	接线方式 Termination	接线外径 Cable OD	尺寸图 Scale diagram
	170004-01-001	3+PE	25A	630V	压接/crimp	8~10mm	
	170006-01-001	5+PE	14A	630V	压接/crimp	8~10mm	
	170007-01-001	6+PE	14A	630V	压接/crimp	8~10mm	
	170008-01-001	7+PE	14A	630V	压接/crimp	8~10mm	
	170009-01-001	5+3+PE	3.6/14A	60/630V	压接/crimp	8~10mm	
	170004-02-001	3+PE	25A	630V	压接/crimp	8~10mm	
	170006-02-001	5+PE	14A	630V	压接/crimp	8~10mm	
	170007-02-001	6+PE	14A	630V	压接/crimp	8~10mm	
	170008-02-001	7+PE	14A	630V	压接/crimp	8~10mm	
	170009-02-001	5+3+PE	3.6/14A	60/630V	压接/crimp	8~10mm	
产品参数 Product Data	工作温度 Operating temperature: -25°C ~ +125°C 插拔次数 Mechanical operation: > 100次 防护等级 Protection degree: IP67/IP68 接触电阻 Contact resistance: ≤5mΩ 绝缘电阻 Insulation resistance: ≥100MΩ			插针材料 Pin contact: CuZn 插孔材料 Socket contact: CuSn 针孔镀层材料 Contact plating: Au			
<div style="display: flex; justify-content: space-around; align-items: flex-start;"> <div style="text-align: center;"> <p>3+PE</p>  </div> <div style="text-align: center;"> <p>3+PE</p>  </div> <div style="text-align: center;"> <p>5+PE</p>  </div> <div style="text-align: center;"> <p>5+PE</p>  </div> <div style="text-align: center;"> <p>6+PE</p>  </div> <div style="text-align: center;"> <p>6+PE</p>  </div> <div style="text-align: center;"> <p>7+PE</p>  </div> <div style="text-align: center;"> <p>7+PE</p>  </div> <div style="text-align: center; margin-top: 20px;"> <p>5+3+PE</p>  </div> <div style="text-align: center; margin-top: 20px;"> <p>5+3+PE</p>  </div> </div>							

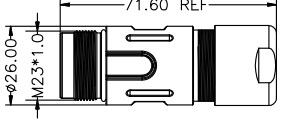

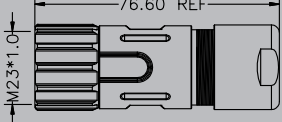

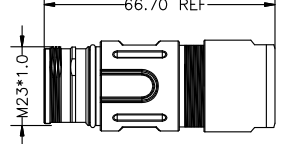

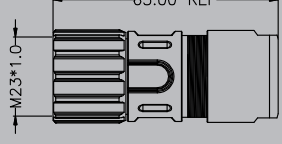



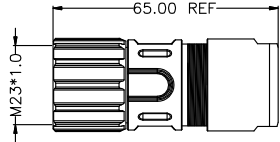

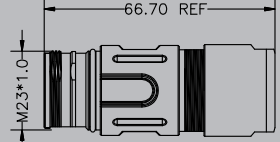

















M23 组装式连接器 / M23 Assembly Connector

产品图 Product picture	订货号 Order No.	芯数 Poles	额定电流 Current rating	额定电压 Voltage rating	接线方式 Termination	接线外径 Cable OD	尺寸图 Scale diagram
	230006-01-001	6	20A	250V	焊接/solder	6~8mm	 <p>72 ref Ø 25 M 2.3 * 1.0</p>
	230007-01-001	7	20A	250V	焊接/solder	6~8mm	
	230009-01-001	8+1	8*8A+1*20A	250V	焊接/solder	6~8mm	
	230009-01-007	6+3	6*8A+3*20A	250V	焊接/solder	6~8mm	
	230012-01-001	12	8A	150V	焊接/solder	6~8mm	
	230016-01-001	16	8A	150V	焊接/solder	6~8mm	
	230017-01-001	17	8A	150V	焊接/solder	6~8mm	
	230019-01-001	16+3	16*8A+3*10A	150V	焊接/solder	6~8mm	
	230006-02-001	6	20A	250V	焊接/solder	6~8mm	 <p>70 ref Ø 26.0</p>
	230007-02-001	7	20A	250V	焊接/solder	6~8mm	
	230009-02-001	8+1	8*8A+1*20A	250V	焊接/solder	6~8mm	
	230009-02-004	6+3	6*8A+3*20A	250V	焊接/solder	6~8mm	
	230012-02-001	12	8A	150V	焊接/solder	6~8mm	
	230016-02-001	16	8A	150V	焊接/solder	6~8mm	
	230017-02-001	17	8A	150V	焊接/solder	6~8mm	
	230019-02-001	16+3	16*8A+3*10A	150V	焊接/solder	6~8mm	
	230006-01-002	6	20A	250V	焊接/solder	6~8mm	 <p>78 ref 58 52 M2.3 * 1.0 Ø 26</p>
	230007-01-002	7	20A	250V	焊接/solder	6~8mm	
	230009-01-002	8+1	8*8A+1*20A	250V	焊接/solder	6~8mm	
	230009-01-004	6+3	6*8A+3*20A	250V	焊接/solder	6~8mm	
	230012-01-003	12	8A	150V	焊接/solder	6~8mm	
	230016-01-002	16	8A	150V	焊接/solder	6~8mm	
	230017-01-002	17	8A	150V	焊接/solder	6~8mm	
	230019-01-003	16+3	16*8A+3*10A	150V	焊接/solder	6~8mm	
	230006-02-002	6	20A	250V	焊接/solder	6~8mm	 <p>75 ref 52 Ø 26</p>
	230007-02-002	7	20A	250V	焊接/solder	6~8mm	
	230009-02-002	8+1	8*8A+1*20A	250V	焊接/solder	6~8mm	
	230009-02-003	6+3	6*8A+3*20A	250V	焊接/solder	6~8mm	
	230012-02-002	12	8A	150V	焊接/solder	6~8mm	
	230016-02-002	16	8A	150V	焊接/solder	6~8mm	
	230017-02-002	17	8A	150V	焊接/solder	6~8mm	
	230019-02-002	16+3	16*8A+3*10A	150V	焊接/solder	6~8mm	

M23 组装式连接器 / M23 Assembly Connector

产品图 Product picture	订货号 Order No.	芯数 Poles	额定电流 Current rating	额定电压 Voltage rating	接线方式 Termination	接线外径 Cable OD	尺寸图 Scale diagram
	230006-01-003	5+PE	30A	630V	压接/crimp	7~12mm	
	230008-01-001	4+3+PE	28A / 8A	600V/300V	压接/crimp	7~12mm	
	230009-01-008	(5+3+PE)-A	28A / 10A	600V/250V	压接/crimp	7~12mm	
	230009-01-009	(5+3+PE)-B	28A / 10A	600V/250V	压接/crimp	7~12mm	
	230012-01-013	4+4+3+PE	28A / 8A/2A	600V/300V/60V	压接/crimp	7~12mm	
	230013-01-001	4+4+4+PE	30A / 8A/3.6A	630V/50V/50V	压接/crimp	7~12mm	
	230006-02-004	5+PE	30A	630V	压接/crimp	7~12mm	
	230008-02-003	4+3+PE	8A / 28A	300V/800V	压接/crimp	7~12mm	
	230009-02-005	(5+3+PE)-A	28A / 10A	600V/250V	压接/crimp	7~12mm	
	230009-02-006	(5+3+PE)-B	28A / 10A	600V/250V	压接/crimp	7~12mm	
	230012-02-008	4+4+3+PE	28A / 8A/2A	600V/300V/60V	压接/crimp	7~12mm	
	230013-02-001	4+4+4+PE	30A / 8A/3.6A	630V/50V/50V	压接/crimp	7~12mm	
	230012-01-008	12	8A	150V	压接/crimp	7~12mm	
	230017-01-003	17	8A	150V	压接/crimp	7~12mm	
	230019-01-005	16+3	16*3A+3*10A	150V	压接/crimp	7~12mm	
	230012-02-004	12	8A	150V	压接/crimp	7~12mm	
	230017-02-005	17	8A	150V	压接/crimp	7~12mm	
	230019-02-003	16+3	16*3A+3*10A	150V	压接/crimp	7~12mm	

M23 组装式连接器 / M23 Assembly Connector

产品图 Product picture	订货号 Order No.	芯数 Poles	额定电流 Current rating	额定电压 Voltage rating	接线方式 Termination	接线外径 Cable OD	尺寸图 Scale diagram		
	230012-01-012	12	8A	150V	压接/crimp	7 ~ 12mm			
	230017-01-006	17	8A	150V	压接/crimp	7 ~ 12mm			
	230019-01-007	16+3	16*3A+3*10A	150V	压接/crimp	7 ~ 12mm			
	230012-02-007	12	8A	150V	压接/crimp	7 ~ 12mm			
	230017-02-007	17	8A	150V	压接/crimp	7 ~ 12mm			
	230019-02-005	16+3	16*3A+3*10A	150V	压接/crimp	7 ~ 12mm			
产品参数 Product Data	工作温度 Operating temperature: -25°C ~ +85°C 插拔次数 Mechanical operation: > 100次 防护等级 Protection degree: IP67/IP68 接触电阻 Contact resistance: ≤5mΩ 绝缘电阻 Insulation resistance: ≥100MΩ				插针材料 Pin contact: CuZn 插孔材料 Socket contact: CuSn 针孔镀层材料 Contact plating: Au				
<div style="display: flex; flex-wrap: wrap; justify-content: space-around; text-align: center;"> <div style="width: 10%;">6pins </div> <div style="width: 10%;">6pins </div> <div style="width: 10%;">5+PE </div> <div style="width: 10%;">5+PE </div> <div style="width: 10%;">7pins </div> <div style="width: 10%;">7pins </div> <div style="width: 10%;">4+3+PE </div> <div style="width: 10%;">4+3+PE </div> <div style="width: 10%;">8+1 </div> <div style="width: 10%;">8+1 </div> </div> <div style="display: flex; flex-wrap: wrap; justify-content: space-around; text-align: center;"> <div style="width: 10%;">6+3 </div> <div style="width: 10%;">6+3 </div> <div style="width: 10%;">(5+3+PE)-A </div> <div style="width: 10%;">(5+3+PE)-A </div> <div style="width: 10%;">(5+3+PE)-B </div> <div style="width: 10%;">(5+3+PE)-B </div> <div style="width: 10%;">12pins </div> <div style="width: 10%;">12pins </div> <div style="width: 10%;">4+4+3+PE </div> <div style="width: 10%;">4+4+3+PE </div> </div> <div style="display: flex; flex-wrap: wrap; justify-content: space-around; text-align: center;"> <div style="width: 10%;">4+4+4+PE </div> <div style="width: 10%;">4+4+4+PE </div> <div style="width: 10%;">16pins </div> <div style="width: 10%;">16pins </div> <div style="width: 10%;">17pins </div> <div style="width: 10%;">17pins </div> <div style="width: 10%;">16+3 </div> <div style="width: 10%;">16+3 </div> </div>									

7/8" 组装式连接器 / 7/8" Assembly Connector

产品图 Product picture	订货号 Order No.	芯数 Poles	额定电流 Current rating	额定电压 Voltage rating	接线方式 Termination	接线外径 Cable OD	尺寸图 Scale diagram
	780003-01-004	3	12A	300V	锁螺丝/screw	6 ~ 12mm	
	780004-01-005	4	9A	300V	锁螺丝/screw	6 ~ 12mm	
	780005-01-004	5	9A	300V	锁螺丝/screw	6 ~ 12mm	
	780003-02-004	3	12A	300V	锁螺丝/screw	6 ~ 12mm	
	780004-02-004	4	9A	300V	锁螺丝/screw	6 ~ 12mm	
	780005-02-006	5	9A	300V	锁螺丝/screw	6 ~ 12mm	
	780003-01-002	3	12A	300V	锁螺丝/screw	6 ~ 12mm	
	780004-01-002	4	9A	300V	锁螺丝/screw	6 ~ 12mm	
	780005-01-002	5	9A	300V	锁螺丝/screw	6 ~ 12mm	
	780003-02-002	3	12A	300V	锁螺丝/screw	6 ~ 12mm	
	780004-02-002	4	9A	300V	锁螺丝/screw	6 ~ 12mm	
	780005-02-002	5	9A	300V	锁螺丝/screw	6 ~ 12mm	
产品参数 Product Data	工作温度 Operating temperature: -25°C ~ +85°C			插针材料 Pin contact: CuZn			
插拔次数 Mechanical operation: > 100次			插孔材料 Socket contact: CuSn				
防护等级 Protection degree: IP67/IP68			针孔镀层材料 Contact plating: Au				
接触电阻 Contact resistance: ≤3mΩ							
绝缘电阻 Insulation resistance: ≥100MΩ							
3pins	3pins	4pins	4pins	5pins	5pins		
							

RD24 组装式连接器 / RD24 Assembly Connector

产品图 Product picture	订货号 Order No.	芯数 Poles	额定电流 Current rating	额定电压 Voltage rating	接线方式 Termination	接线外径 Cable OD	尺寸图 Scale diagram
	240007-01-001	6+PE	8A	250V	锁螺丝/screw	6 ~ 8mm	
	240007-02-001	6+PE	8A	250V	锁螺丝/screw	6 ~ 8mm	
	240007-01-002	6+PE	8A	250V	锁螺丝/screw	6 ~ 8mm	
	240007-02-002	6+PE	8A	250V	锁螺丝/screw	6 ~ 8mm	

**产品参数
Product Data**

工作温度 Operating temperature: -25°C ~ +85°C
 插拔次数 Mechanical operation: > 100次
 防护等级 Protection degree: IP67/IP68
 接触电阻 Contact resistance: ≤ 10mΩ
 绝缘电阻 Insulation resistance: ≥ 100MΩ

插针材料 Pin contact: CuZn
 插孔材料 Socket contact: CuSn
 针孔镀层材料 Contact plating: Au

6+PE



6+PE

